

HFA160MD40C

Ultrafast, Soft Recovery Diode

Features

- Reduced RFI and EMI
- Reduced Snubbing
- Extensive Characterization of Recovery Parameters

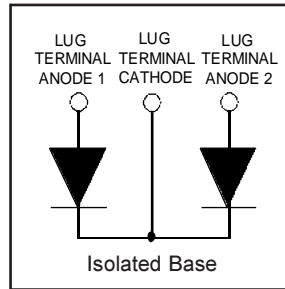

$V_R = 400V$
$V_F(\text{typ.})^{\textcircled{3}} = 0.9V$
$I_{F(AV)} = 160A$
$Q_{rr}(\text{typ.}) = 260nC$
$I_{RRM}(\text{typ.}) = 7.1A$
$t_{rr}(\text{typ.}) = 50ns$
$di_{(rec)M}/dt(\text{typ.})^{\textcircled{3}} = 260A/\mu s$

Description

HEXFRED™ diodes are optimized to reduce losses and EMI/RFI in high frequency power conditioning systems. An extensive characterization of the recovery behavior for different values of current, temperature and di/dt simplifies the calculations of losses in the operating conditions. The softness of the recovery eliminates the need for a snubber in most applications. These devices are ideally suited for power converters, motors drives and other applications where switching losses are significant portion of the total losses.

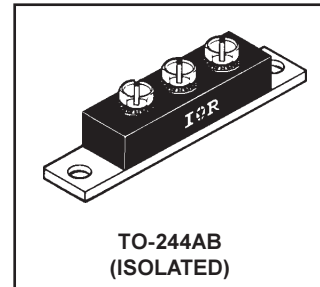

Absolute Maximum Ratings (per Leg)

	Parameter	Max.	Units
V_R	Cathode-to-Anode Voltage	400	V
$I_F @ T_C = 25^\circ C$	Continuous Forward Current	142	A
$I_F @ T_C = 100^\circ C$	Continuous Forward Current	68	
I_{FSM}	Single Pulse Forward Current ^①	900	
E_{AS}	Non-Repetitive Avalanche Energy ^②	1.4	mJ
$P_D @ T_C = 25^\circ C$	Maximum Power Dissipation	225	W
$P_D @ T_C = 100^\circ C$	Maximum Power Dissipation	91	
T_J T_{STG}	Operating Junction and Storage Temperature Range	-55 to +150	C

Thermal - Mechanical Characteristics

	Parameter	Min.	Typ.	Max.	Units
R_{thJC}	Junction-to-Case, Single Leg Conducting	—	—	0.55	°C/W K/W
	Junction-to-Case, Both Legs Conducting	—	—	0.28	
R_{thCS}	Case-to-Sink, Flat, Greased Surface	—	0.10	—	
Wt	Weight	—	79 (2.8)	—	g (oz)
	Mounting Torque ^④	30 (3.4)	—	40 (4.6)	lbf·in
	Terminal Torque	30 (3.4)	—	40 (4.6)	(N·m)
	Vertical Pull	—	—	80	lbf·in
	2 inch Lever Pull	—	—	35	

Note: ^① Limited by junction temperature
^② L = 100µH, duty cycle limited by max T_J
^③ 125°C

^④ Mounting surface must be smooth, flat, free or burrs or other protrusions. Apply a thin even film or thermal grease to mounting surface. Gradually tighten each mounting bolt in 5-10 lbf·in steps until desired or maximum torque limits are reached. Module

HFA160MD40C

PD-2.454 rev. B 12/98

International
IOR Rectifier

Electrical Characteristics (per Leg) @ $T_J = 25^\circ\text{C}$ (unless otherwise specified)

Parameter	Min.	Typ.	Max.	Units	Test Conditions
V_{BR} Cathode Anode Breakdown Voltage	400	—	—	V	$I_R = 100\mu\text{A}$
V_{FM} Max Forward Voltage	—	1.0	1.2	V	$I_F = 80\text{A}$ $I_F = 160\text{A}$ See Fig. 1 $I_F = 80\text{A}, T_J = 125^\circ\text{C}$
	—	1.2	1.4		
	—	0.90	1.1		
I_{RM} Max Reverse Leakage Current	—	1.5	9.0	μA	$V_R = V_R$ Rated See Fig. 2 $T_J = 125^\circ\text{C}, V_R = 320\text{V}$
	—	2.3	12	mA	
C_T Junction Capacitance	—	280	380	pF	$V_R = 200\text{V}$ See Fig. 3
L_S Series Inductance	—	6.0	—	nH	From top of terminal hole to mounting plane

Dynamic Recovery Characteristics (per Leg) @ $T_J = 25^\circ\text{C}$ (unless otherwise specified)

Parameter	Min.	Typ.	Max.	Units	Test Conditions
t_{rr} Reverse Recovery Time	—	50	—	ns	$I_F = 1.0\text{A}, di/dt = 200\text{A}/\mu\text{s}, V_R = 30\text{V}$ $T_J = 25^\circ\text{C}$ See Fig. 5 $T_J = 125^\circ\text{C}$ See Fig. 6
t_{rr1}	—	73	110		
t_{rr2}	—	240	360		
I_{RRM1} Peak Recovery Current	—	7.1	15	A	$T_J = 25^\circ\text{C}$ See Fig. 6 $T_J = 125^\circ\text{C}$ See Fig. 7
	I_{RRM2}	—	15		
Q_{rr1} Reverse Recovery Charge	—	260	700	nC	$T_J = 25^\circ\text{C}$ See Fig. 7 $T_J = 125^\circ\text{C}$ See Fig. 8
	Q_{rr2}	—	1800		
$di_{(rec)M}/dt1$ Peak Rate of Fall of Recovery Current	—	300	—	A/ μs	$T_J = 25^\circ\text{C}$ See Fig. 8 $T_J = 125^\circ\text{C}$ See Fig. 8
$di_{(rec)M}/dt2$ During t_b	—	260	—		

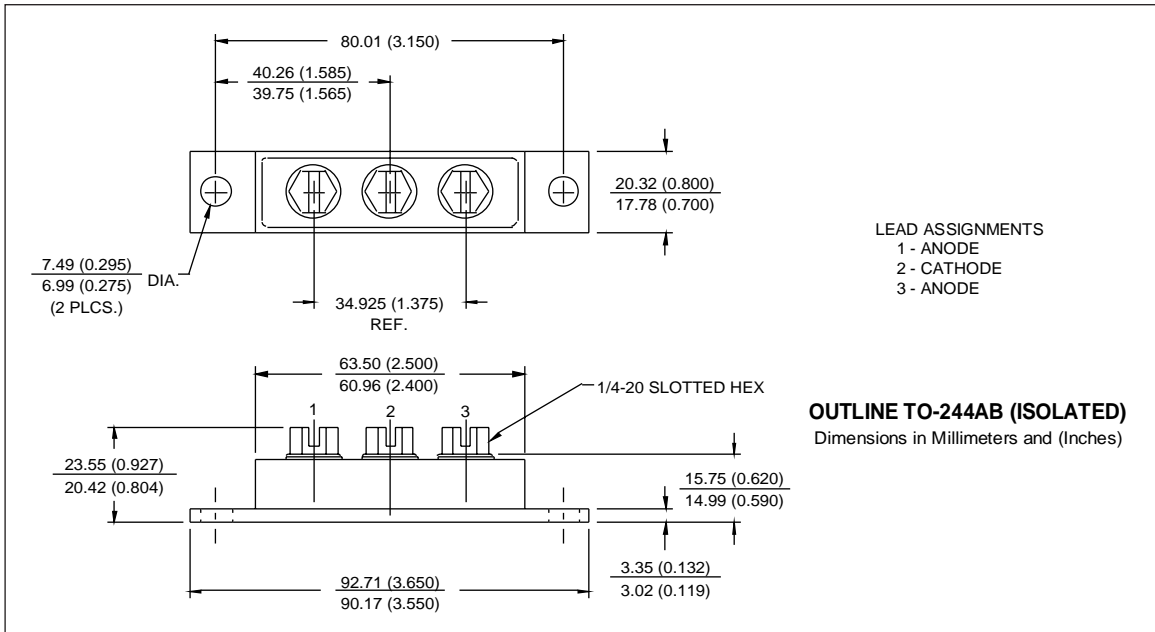

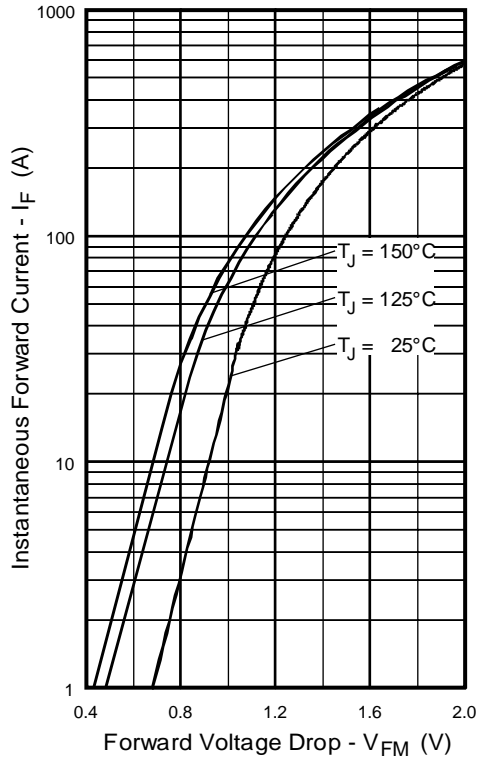

Fig. 1 - Maximum Forward Voltage Drop vs. Instantaneous Forward Current, (per Leg)

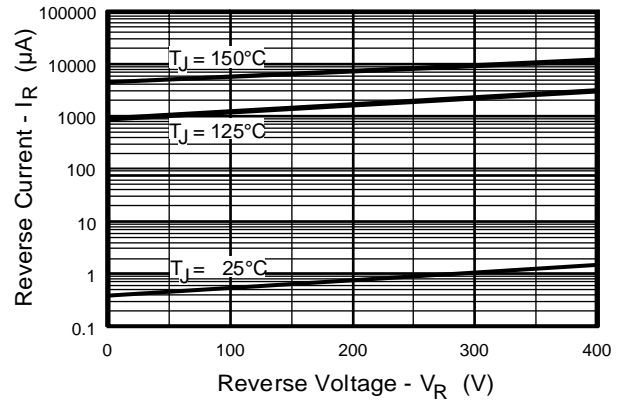

Fig. 2 - Typical Reverse Current vs. Reverse Voltage, (per Leg)

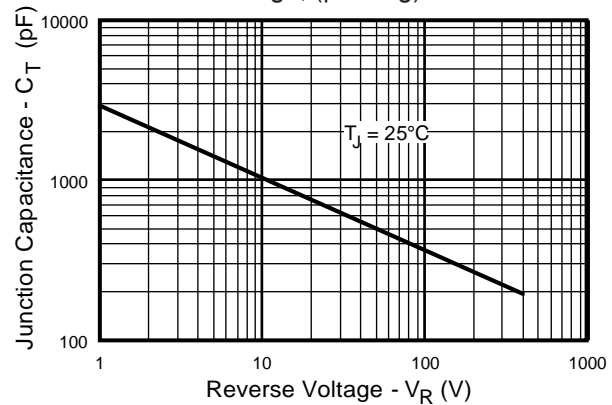

Fig. 3 - Typical Junction Capacitance vs. Reverse Voltage, (per Leg)

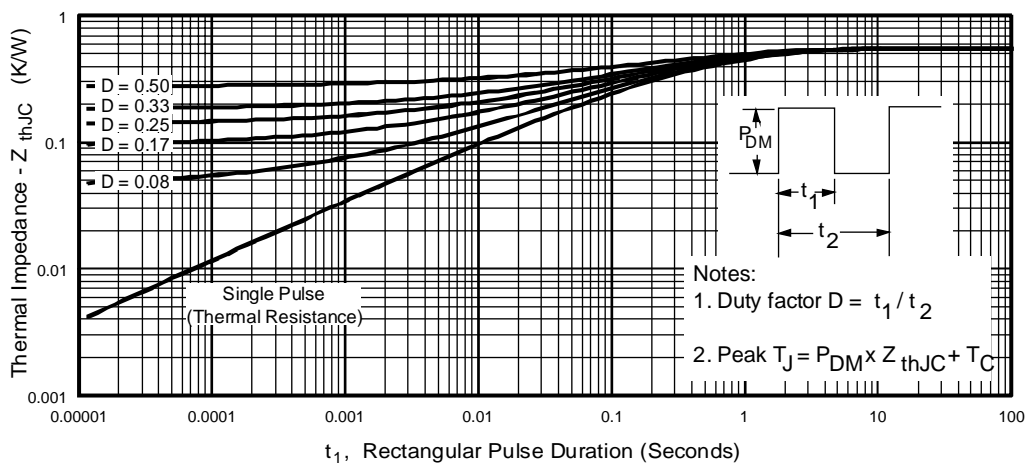

Fig. 4 - Maximum Thermal Impedance Z_{thJC} Characteristics, (per Leg)

HFA160MD40C

PD-2.454 rev. B 12/98

International
IOR Rectifier

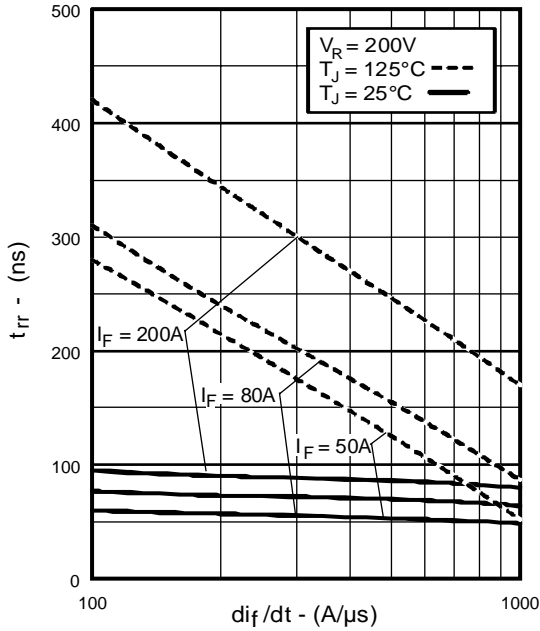

Fig. 5 - Typical Reverse Recovery vs. di_f/dt , (per Leg)

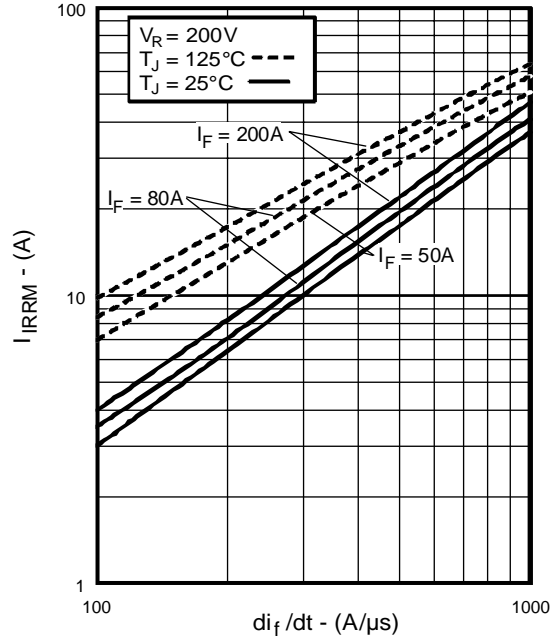

Fig. 6 - Typical Recovery Current vs. di_f/dt , (per Leg)

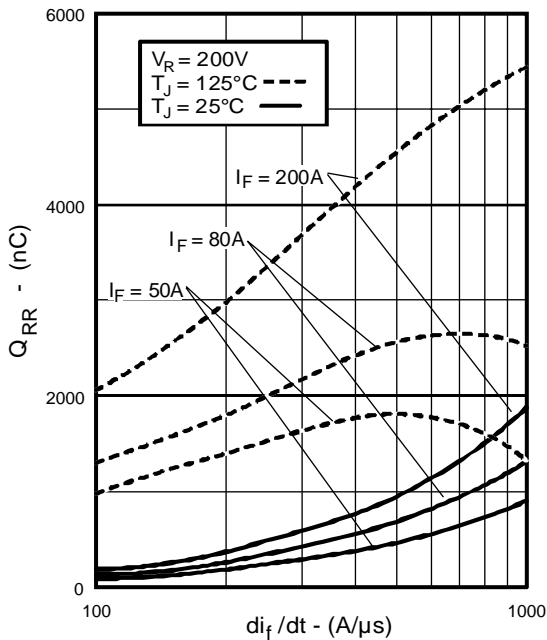

Fig. 7 - Typical Stored Charge vs. di_f/dt , (per Leg)

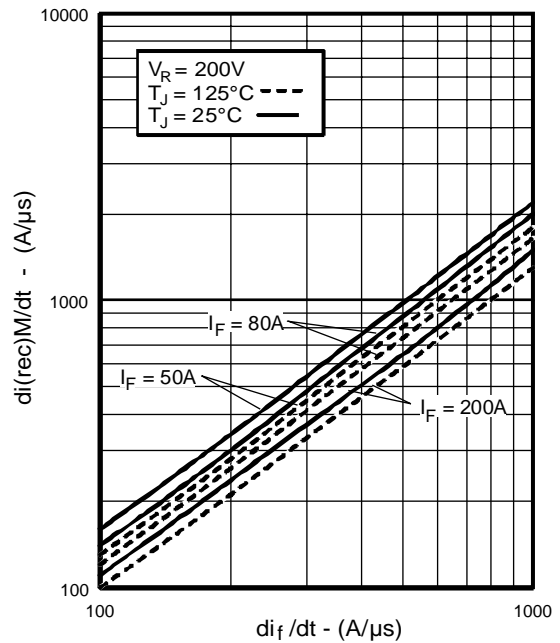

Fig. 8 - Typical $di_{(rec)M}/dt$ vs. di_f/dt , (per Leg)

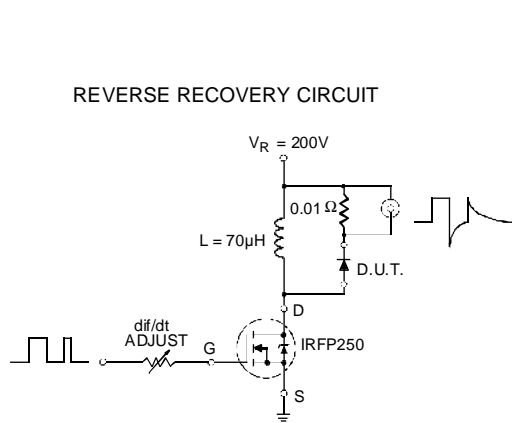
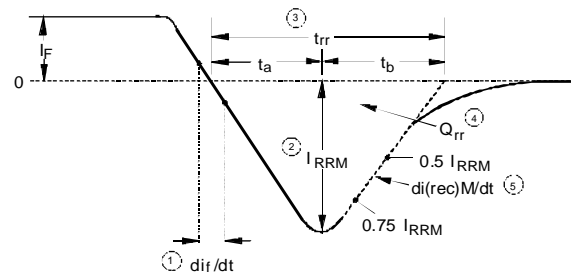

Fig. 9 - Reverse Recovery Parameter Test Circuit



1. di/dt - Rate of change of current through zero crossing
2. I_{RRM} - Peak reverse recovery current
3. t_{rr} - Reverse recovery time measured from zero crossing point of negative going I_F to point where a line passing through $0.75 I_{RRM}$ and $0.50 I_{RRM}$ extrapolated to zero current
4. Q_{rr} - Area under curve defined by t_{rr} and I_{RRM}

$$Q_{rr} = \frac{t_{rr} \times I_{RRM}}{2}$$
5. $di_{(rec)}/dt$ - Peak rate of change of current during t_b portion of t_{rr}

Fig. 10 - Reverse Recovery Waveform and Definitions

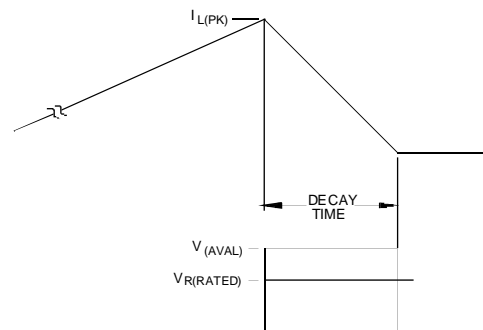
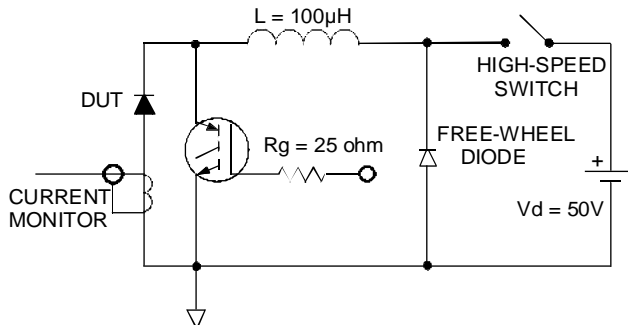

Fig. 11 - Avalanche Test Circuit and Waveforms